

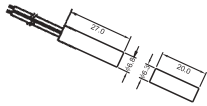

## Wciskane

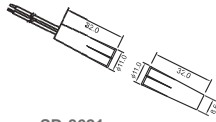

SD-8611



SD-8621

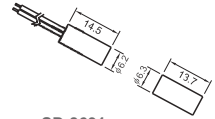

SD-8631

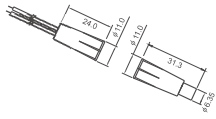

SD-8641

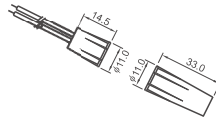

SD-8650

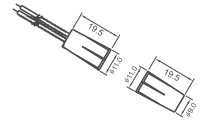

SD-8651

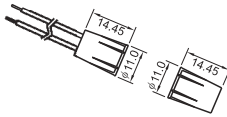

SD-10

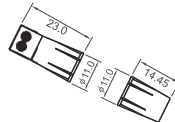

SD-1175T

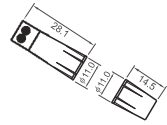

SD-175T

Model Number	Switch Rating	Resistance	Gap	Wiring
SD-8611	28V@1.0A	0.3ΩMax	17mm	450mm/AWG#22 wire
SD-8621	28V@1.0A	0.3ΩMax	19mm	450mm/AWG#22 wire
SD-8631	28V@0.5A	0.3ΩMax	9.5mm	450mm/AWG#22 wire
SD-8641	28V@1.0A	0.3ΩMax	26mm	330mm/AWG#22 wire
SD-8650	28V@0.5A	0.3ΩMax	11.5mm	610mm/AWG#22 wire
SD-8651	28V@1.0A	0.3ΩMax	11mm	450mm/AWG#22 wire
SD-10	28V@0.5A	0.3ΩMax	11mm	450mm/AWG#22 wire
SD-1175T	28V@0.5A	0.3ΩMax	8mm	Screw Terminal
SD-175T	28V@1.0A	0.3ΩMax	12mm	Screw Terminal

## Surface Mount

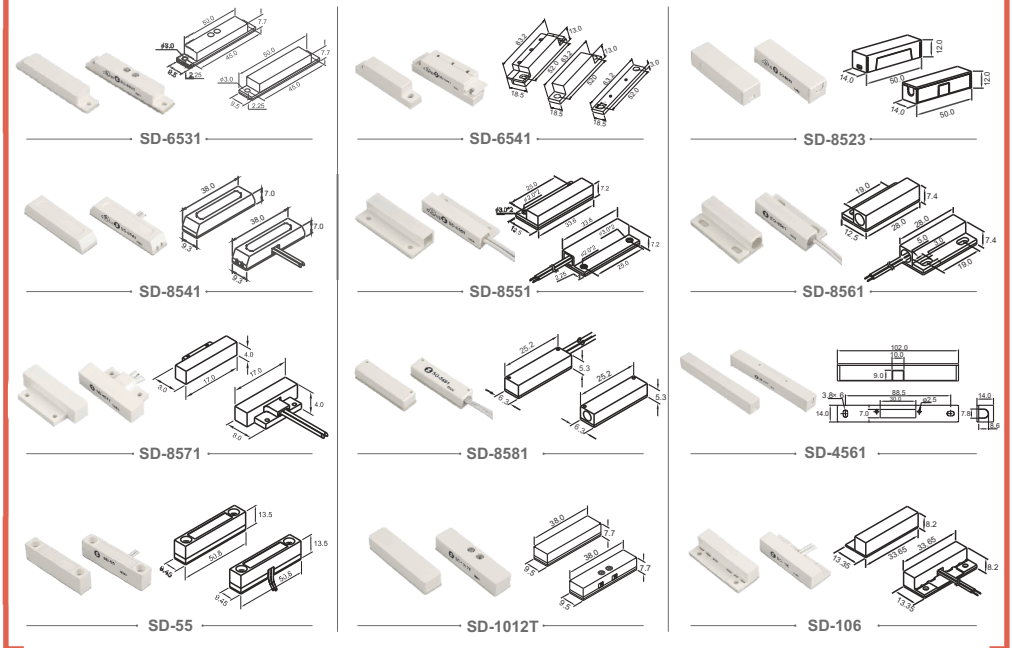

Model Number	Switch Rating	Resistance	Gap	Wiring	Mounting
SD-6531	28V@1.0A	0.3ΩMax	19mm	Screw Terminal	Screw
SD-6541	28V@1.0A	0.3ΩMax	19mm	Screw Terminal	Screw
SD-8523	28V@1.0A	0.3ΩMax	20mm	Screw Terminal	Screw
SD-8541	28V@1.0A	0.3ΩMax	16mm	660mm/AWG#22 wire	3M Adhesive Tape
SD-8551	28V@1.0A	0.3ΩMax	19.5mm	450mm/AWG#22 wire	3M Adhesive Tape
SD-8561	28V@1.0A	0.3ΩMax	26mm	450mm/AWG#22 wire	3M Adhesive Tape
SD-8571	28V@0.5A	0.3ΩMax	8mm	280mm/AWG#22 wire	Screw
SD-8581	28V@1.0A	0.3ΩMax	9.5mm	450mm/AWG#22 wire	Screw
SD-4561	28V@1.0A	0.3ΩMax	50mm	Screw Terminal	3M Adhesive Tape
SD-55	28V@1.0A	0.3ΩMax	30mm	240mm/AWG#22 wire	3M Adhesive Tape/Screw
SD-1012T	28V@1.0A	0.3ΩMax	19mm	Screw Terminal	3M Adhesive Tape
SD-106	28V@1.0A	0.3ΩMax	21mm	450mm/AWG#22 wire	3M Adhesive Tape/Screw