

Industrial LuNAR™ DT AM Grade 3

Taking Intelligence to New Heights



Remote Control & Diagnostic Capabilities

High Ceiling Mount Detector Installation Guide

RISCO
GROUP
Creating Security Solutions *With Care.*
riscogroup.com

General Description

The **Industrial LuNAR DT AM Grade 3** is a dual technology ceiling detector with a mounting height of up to 8.6m (28ft) that incorporates RISCO Group's Anti-Cloak™ Technology (ACT™). The detector has an Intelligent Digital Signal Processing method that automatically adjusts the alarm threshold and pulse count verification according to actual intruder crossing speed and environmental factors, providing superior detection and false alarm immunity.

The **Industrial LuNAR DT AM Grade 3** can operate as a regular relay detector connected to any control panel, or as an addressable BUS detector when connected to RISCO Group's ProSYS control panel via the RS485 BUS.

Industrial LuNAR DT AM Grade 3 Features

- ◆ PD6662, EN50131-1, TS50131-2-4 Grade 3
- ◆ Addressable Dual Technology detector with Anti-Cloak™ Technology
- ◆ Up to 8.6 m (28ft) mounting height
- ◆ 360° by 18m (59ft) diameter coverage pattern
- ◆ 3 independent PIR channels for customized coverage
- ◆ Intelligent Digital Signal Processing – alarm verification and decision thresholds adjusted according to actual intruder crossing speed
- ◆ Built-in Triple EOL resistors, jumper selectable
- ◆ Active IR for Anti-Masking meeting TS50131 requirements
- ◆ Ceiling and cover tampers
- ◆ "Green Line" setting – for disabling the MW when the premises are occupied
- ◆ Opto-relays for low current consumption and long life
- ◆ Remote and Local Self Test
- ◆ Remote SET input
- ◆ Remote RC control input
- ◆ PIR coverage optimization by sliding the lenses
- ◆ Microwave Range Adjustment manually (analog trimmer) and remotely (digital setting)
- ◆ Trouble Indication (by LEDs or via communication)
- ◆ 3 Triple color LEDs for easy walk testing
- ◆ Advanced Remote control and diagnostics
- ◆ Reduced Power Consumption when connected to RISCO Group's ProSYS

Remote Control and Diagnostic Features*

- ◆ Remote microwave adjustment enables one-man walk test.
- ◆ Diagnostic tools include detector input voltage reading and status of each PIR channel and MW channel (signal voltage and noise levels), AM channel (signal voltage), SW version verification.
- ◆ Remote display and control of detector settings: MW adjustment, ACT on/off, LEDs on/off.
- ◆ Remote trouble indication (Pass/Fail) for the PIR, MW and power supply input
- ◆ Control of MW bypass (during MW trouble) and MW disable during Disarm ("Green Line") when connected to ProSYS.

*Via the optional Bi-Directional Infrared Remote Control, or the ProSYS Upload/Download Software and Keypad.

Detection Method

The Industrial LuNAR DT AM Grade 3 detection is based on:

- ◆ **PIR** (Passive Infra-Red) - which responds to changes in the IR radiation caused when an intruder crosses the protected area.
- ◆ **MW** (Microwave) - which transmits signals and analyzes the frequency changes of the reflected echo from an intruder using Doppler Effect.

ALARM is initiated only when both technologies trigger simultaneously (except for certain situations in the ACT mode-see page 4 – "How ACT™ Works"), thus greatly reducing the possibility of false alarms.

How ACT™ Works

Anti-Cloak™ Technology (ACT™) provides the benefits of DT (Dual Technology) while avoiding its drawbacks. This patent pending innovation has created a new standard for detectors.

Dual Technology, a combination of PIR +MW, was an important development for the security industry...but, it has 2 major weaknesses:

IR emission blocking cloaks employed by intruders enable avoidance of detection.

PIR sensitivity is reduced when the protected area's ambient temperature approaches body temperature.

Responding to requests from its customer base to solve these pressing problems, RISCO Group developed ACT™ -a revolutionary anti-cloak solution.

ACT™ prevents the alarm system from being bypassed, by neutralizing attempts to camouflage IR radiation. Using unique pattern recognition algorithms, ACT™ distinguishes between the weak IR signal of a moving intruder and the background noise and thermal interferences that may cause false alarms.

Once the presence of an intruder is recognized, ACT™ switches the system automatically from dual channel PIR/MW mode to single channel MW mode for a predetermined period of time, in order to trigger an alarm utilizing the MW channel, and then returns to dual channel mode.

In the second case, when the ambient temperature approaches body temperature, the ACT™ switches to microwave-only detection.

Offering significantly higher detection capabilities as well as immunity from false alarms, ACT™ thwarts even the most sophisticated burglars.

Industrial LuNAR DT AM Grade 3 Configuration Options

The **Industrial LuNAR DT AM Grade 3** can be configured and/or diagnosed remotely via one of the options:

	Manual configuration	Remote Control Device	ProSYS Bus Control
ACT Mode	✓	✓	✓
LEDs	✓	✓	✓
MW Sensitivity	✓ (by trimmer)	✓	✓
Diagnostics	-	✓	✓
Status/Trouble/Info Reports	-	✓	✓
AM Diagnostics	-	-	✓
MW Bypass	-	-	✓
MW Disable on Disarm ("Green Line")	-	-	✓

LED Display

The three Tri color LEDs in the **Industrial LuNAR DT AM Grade 3**, operate as herein described:

LED	STATE	MEANING
Red	Steady	Detector alarm (simultaneous PIR and MW detection)
	Flashing with low frequency	Indicates malfunctioned communication with ProSYS
	Flashing with high frequency	AM detection
Green	Steady	Microwave detection
	Flashing	Trouble in the MW channel
Orange	Steady	PIR detection
	Flashing	Trouble in the PIR channel
All LEDs	Flashing with change of color	Upon power up

INSTALLATION

Preliminary steps:

- ◆ Before installation, study the space to be protected carefully in order to choose the exact location of the unit for the best possible coverage.
- ◆ Never install the LuNAR in an environment that causes an alarm condition in one technology.
- ◆ Avoid installations where rotating machines (e.g. fans) are normally in operation within the coverage pattern. Point the unit away from glass exposed to the outdoors and objects that may change temperature rapidly.
- ◆ Do not mount the detector in direct sunlight or near any heat sources. Detection sectors should be pointed either towards a wall, floor but not towards windows or curtains. The installation surface should be solid, smooth and vibration free
- ◆ Eliminate interference from nearby outside sources.
- ◆ For optimum detection, select a location likely to intercept an intruder moving across the coverage pattern.
- ◆ Recommended mounting heights that allow 18m (59ft) detection, are from 3.7m to 8.6m.
- ◆ The detector must be mounted on the ceiling, preferably in the center of the room.

Typical Industrial LuNAR detection coverage and installation height, are illustrated below:

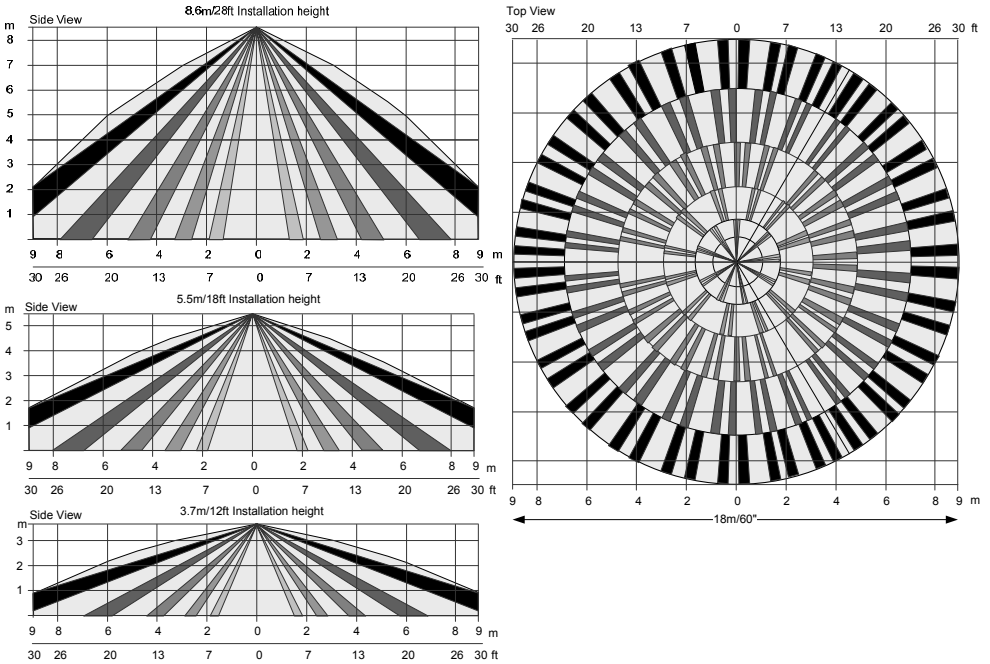

NOTE:

When installing the Industrial LuNAR DT AM Grade 3 detector in a room occupied with high volume interfering elements, MW detection may be affected.

Installation Process:

To open the detector (**Figure 1**), remove the cover by inserting a screwdriver (1) in the recess between the detector's protection cap and the cover. The cover will remain attached to the base of the detector.

Using a Philips screwdriver, release the upper cover screw (2) and gently pull upward the detector's upper cover.

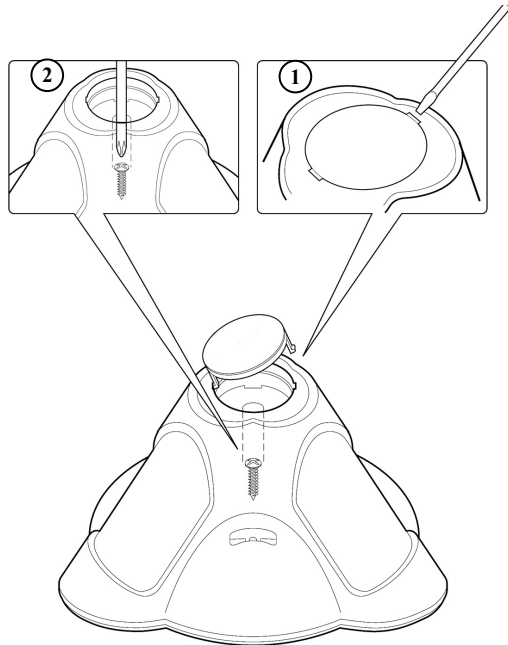

FIGURE 1

Release the PCB holding screw (**Figure 2**) located on the right hand side of the PCB (1), pull gently the two release clips (2) outward and remove the PCB.

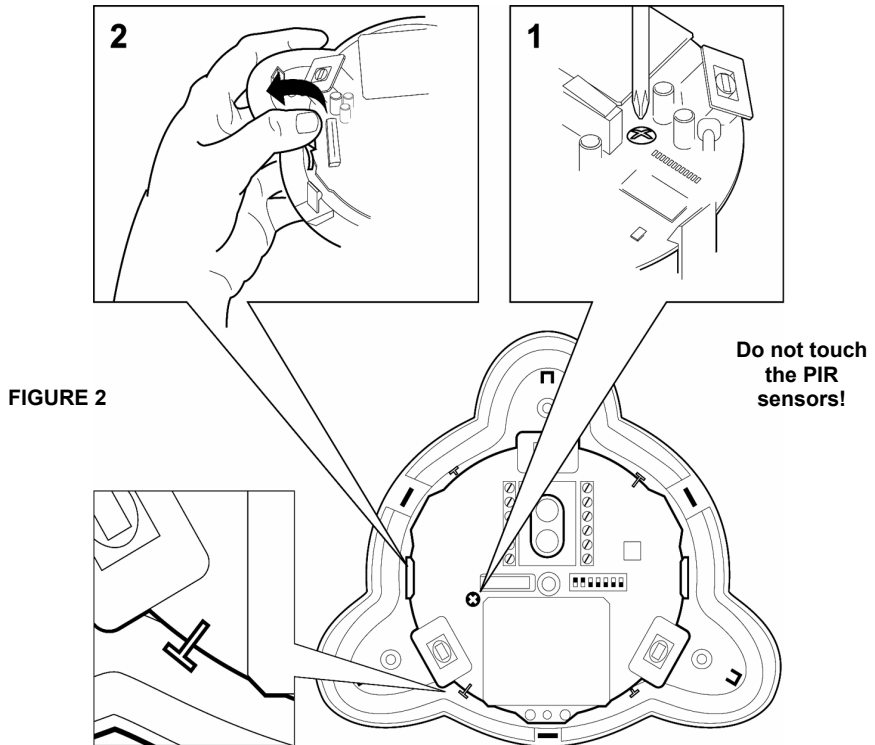

FIGURE 2

If required, open **(Figure 3)** the wiring channels knockout using a cutter (1, 2) and knockout holes in the rear cover (3, 4) using a screwdriver.

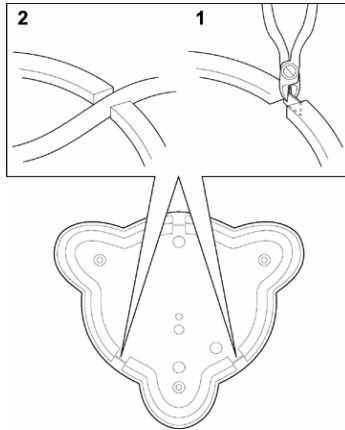
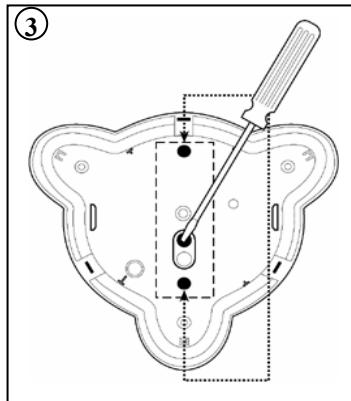
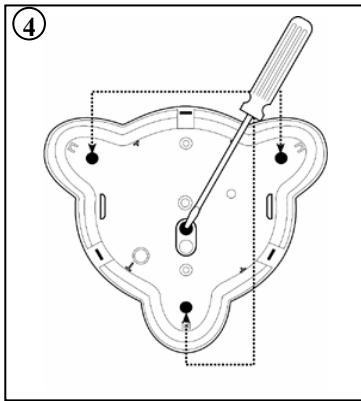
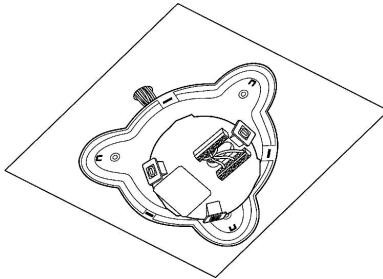

FIGURE 3



Insert the cable via the cable opening (**Figure 4**) and connect the desired wires as described in “Step 4- Wiring”.

FIGURE 4



Mount the rear cover in its final location (**Figure 5**) using the 3 mounting screws and seal the remaining open holes with sealant.



NOTE:

When a single gang box is used, use 2 additional screws to mount the base to the single gang box. The back tamper cannot be used in this case!

FIGURE 5

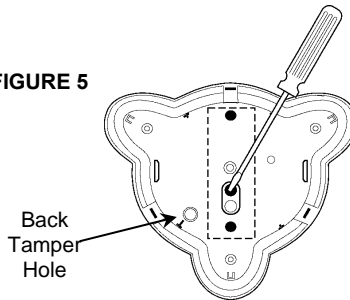

Return the PCB to its previous location and verify that it is well secured by the holding clips and the screw.

Perform lens adjustment and DIP switch settings as described in “**Lens Adjustment**” on page 12 and on page 15.

Mount the top cover on the detector’s base.

Tighten the top cover’s central screw.

Replace the detector’s protection cap.



NOTE:

If ceiling tamper is desired, break and open the ceiling tamper hole at the detector’s base!

Lens Adjustment:

The Lunar has three - Fresnel lenses attached to the cover, located in sensor protective sleeves. Adjust the position of the lenses based on the ceiling mounting height as follows:

Press the 2 clips attaching the sleeve (**Figure 6**) to the detector’s cover, and gently pull out the sleeve.

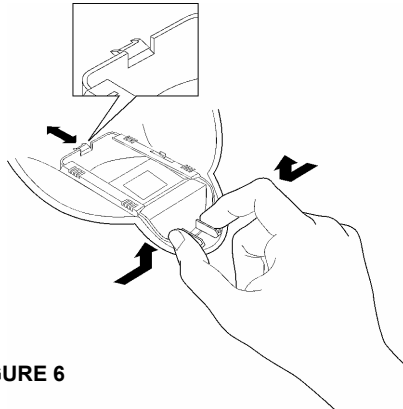
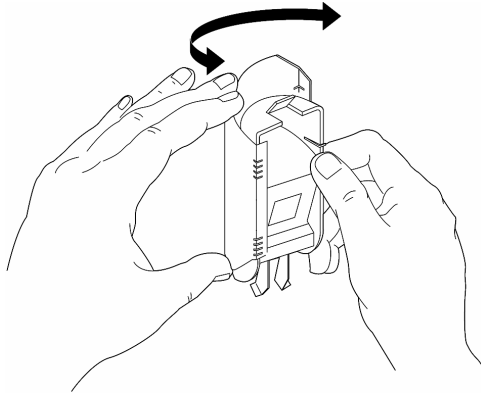





FIGURE 6

Remove the lens from the sleeve (**Figure 7**) by gently lifting it from the holding pins that secure it to the sides of the sleeve.

FIGURE 7



Place the two pins, which are located on both sides of the sleeve into the matching slots on the lens. Use the following table to select the desired lens position.

	Lens Position	Mounting Height
1		2.7 - 4.9m 9 - 16ft
2 (DEFAULT)		4.9 - 6.2m 16 - 20.3ft
3		6.2 - 7.8m 20.3 - 25.6ft
4		7.8 - 8.6m 25.6 - 28ft

Return the protective sleeve back into place on the detector front cover. Repeat steps 1 to 5 for the remaining 2 lenses.





NOTES:

Below 3.7m mounting height, the coverage diameter starts decreasing, and at 2.7m height coverage diameter is 15m (50ft).

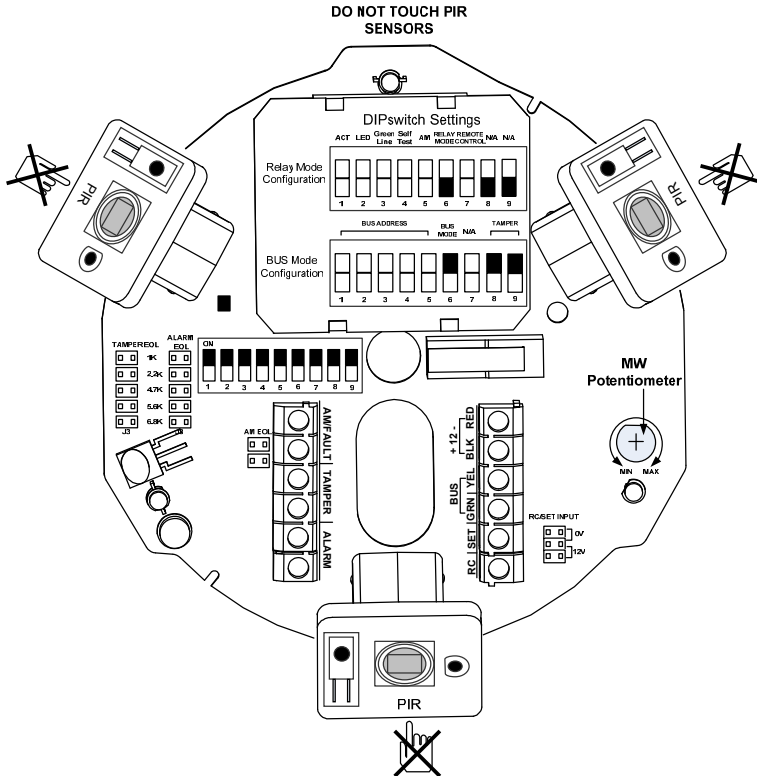
For customized coverage, it is possible to set the position of each lens to a different height, according to the installation conditions.



Selectors and Jumpers

RC/SET INPUT	Used to determine the polarity of the external inputs.	
		12V: 12v has to be connected in order activate the function. GND or N.C. has no influence on the RC/SET status. (see Relay mode DIP switches configuration)
		0V: The GND has to be connected in order to activate the function. 12v or N.C. has no influence on the RC/SET status. (see Relay mode DIP switches configuration)

EOL RESISTORS JUMPERS

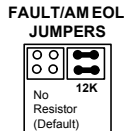
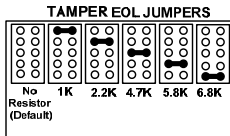
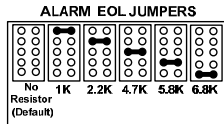

The jumpers are used when connecting the detector to a DEOL or TEOL Zone. The jumpers allow the selection of TAMPER, ALARM E.O.L resistors (1K, 2.2K, 4.7K, 5.6K or 6.8K), according to the control panel settings. An additional double jumper allows the connection of 12K FAULT/AM E.O.L resistor (see EOL Resistors Schematic).

Follow the terminal block connection diagram when connecting the detector to a Double/Triple End Of Line (DEOL/TEOL) Zone.

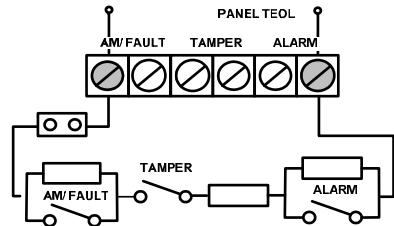
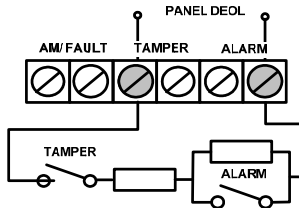

Schematic of EOL Resistors

DIP Switch Settings

The Industrial LuNAR DT AM Grade 3 has a 9 position DIP switch that changes functionality for use in **Relay** mode or in **BUS** operation mode. Set the DIP switch according to the tables below:



Factory Default Settings:

Relay Mode Configuration (DIP switch 6=OFF):

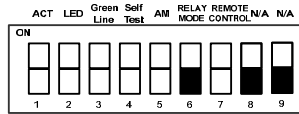

DIP switch Number	Description	
1	Used to determine the operation of the ACT DIP switch ON: ACT is enabled DIP switch OFF: ACT is disabled (default factory)	
2	Used to determine the operation of the detector's LEDs Dip switch ON: LEDs are enabled (default factory) DIP switch OFF: LEDs are disabled	
3	Used to determine the operation of the "Green Line" (See Note below) DIP switch ON: "Green Line" is enabled DIP switch OFF: "Green Line" is disabled (default factory)	
4	Used to determine the type of Self Test (See Note below) DIP switch ON: Local Self Test: In case the local self test fails, the FAULT/AM Relay is activated for a period of 2.5 seconds. DIP switch OFF: Remote Self Test (default factory): In case the remote self test passes, the Alarm Relays are activated for a period of 5 secs. In case the test fails, FAULT/AM Relay is activated for a period of 2.5 seconds.	
5	Used to determine whether Active IR Anti-Masking is active. (See Note below) DIP switch ON: Enable DIP switch OFF: Disable (default factory)	
6	Used to determine the detector's connection mode DIP switch OFF: Relay mode	
7	Used to determine if the Remote Control communication is enabled or disabled. DIP switch ON: RC communication is always enabled. DIP switch OFF: RC communication depends on the voltage applied to the terminal block "RC" (default factory) When an activation signal is applied to the RC input of the terminal block, RC is enabled. IMPORTANT: Turn dipswitch 7 "OFF" after installation and when leaving the site for security reasons. This will prevent unauthorized use of a remote control unit that may be used to disable the detector.	
	8-9	DIP switches OFF
		NOTE: See Set Terminal Blocks for activation details.



BUS Mode Configuration (DIP switch 6=ON):

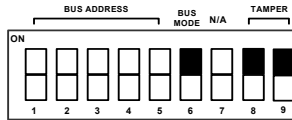

DIP switch Number	Description
1-5	Used to set the detector ID number. (See Table 1) Set the ID number in the same way as for any other ProSYS accessory.
6	Used to determine the detector's connection mode. DIP switch ON: ProSYS connection – BUS configuration
	NOTE: Upon power up or normal operation, the LuNAR waits 10 seconds for ProSYS communication. Communication problem may occur due to bad wiring, wrong address, or ProSYS not configured properly; RED LEDs will continuously flash until the problem is solved.
7	Not applicable (RC communication is automatically enabled when entering Walk Test mode in the ProSYS and disabled otherwise).
8-9	DIP Switch ON: in order to enable the detector to report the tamper status to ProSYS.

Table 1: ID Settings for BUS connection

ID	1	2	3	4	5
01	OFF	OFF	OFF	OFF	OFF
02	ON	OFF	OFF	OFF	OFF
03	OFF	ON	OFF	OFF	OFF
04	ON	ON	OFF	OFF	OFF
05	OFF	OFF	ON	OFF	OFF
06	ON	OFF	ON	OFF	OFF
07	OFF	ON	ON	OFF	OFF
08	ON	ON	ON	OFF	OFF
09	OFF	OFF	OFF	ON	OFF
10	ON	OFF	OFF	ON	OFF
11	OFF	ON	OFF	ON	OFF
12	ON	ON	OFF	ON	OFF
13	OFF	OFF	ON	ON	OFF
14	ON	OFF	ON	ON	OFF
15	OFF	ON	ON	ON	OFF
16	ON	ON	ON	ON	OFF
ID	1	2	3	4	5
17	OFF	OFF	OFF	OFF	ON
18	ON	OFF	OFF	OFF	ON
19	OFF	ON	OFF	OFF	ON
20	ON	ON	OFF	OFF	ON
21	OFF	OFF	ON	OFF	ON
22	ON	OFF	ON	OFF	ON
23	OFF	ON	ON	OFF	ON
24	ON	ON	ON	OFF	ON
25	OFF	OFF	OFF	ON	ON
26	ON	OFF	OFF	ON	ON
27	OFF	ON	OFF	ON	ON
28	ON	ON	OFF	ON	ON
29	OFF	OFF	ON	ON	ON
30	ON	OFF	ON	ON	ON
31	OFF	ON	ON	ON	ON
32	ON	ON	ON	ON	ON

Terminal Blocks

TERMINAL BLOCK 1	DESCRIPTION
+12V (RED)	Power supply positive (+) input voltage
- (BLK)	Common to control panel power supply
BUS (GRN)	Used for data communication with the ProSYS
BUS (YEL)	Used for data communication with the ProSYS
SET *	Used to remotely SET/UNSET the detector. When an activation signal (see RC/SET Activation jumper for settings) is applied to the SET input of the terminal block: <ul style="list-style-type: none"> ♦ AM will be disabled (if the AM DIP switch 5 was previously ON) ♦ MW module is enabled (if the Green Line DIP switch 3 was previously ON). Removing an activation signal will cause a Self Test (if the Remote Self Test DIP switch 4 was previously OFF).
RC * (REMOTE CONTROL)	Used to enable/disable the remote control communication, only when DIP switch 7 is "OFF". When an activation signal (see RC/SET input jumper for settings) is applied to the RC input of the terminal block, Remote Control will be enabled . Note: DIP switch 7 "ON" constantly enables RC communication.



IMPORTANT:

Turn DIP switch 7 "OFF" after installation and when leaving the site for security reasons. This will prevent unauthorized use of a remote control unit that may be used to disable the detector.



*

Not relevant in BUS mode

TERMINAL BLOCK 2	DESCRIPTION
AM/FAULT	Normally closed output The AM/FAULT output opens in the following events: Detector is masked (ALARM also opens in this case) Self Test failed Input voltage is low (6VDC-8VDC)
TAMPER	Normally closed output
ALARM	Normally closed output

Walk Test

**NOTE:**

To perform the walk test, first enable the LEDs.

Two minutes after applying power (warm-up period), walk test the detector over the entire protected area to verify proper operation of the detector and observe the Tri - color LED. The edge of the microwave pattern is determined by the first red LED activation (both PIR and MW LEDs are triggered).

**NOTE:**

If the PIR/MW LEDs do not TURN ON, probably it means that there is a problem with either the lens (PIR) position, or MW adjustment!

Adjust the microwave sensitivity by turning the PCB potentiometer (using a screwdriver), or by using the Remote Control device. Walk test the unit from all directions to determine all the detection pattern boundaries.

**NOTE:**

Adjust the MW to the lowest possible setting that will still provide enough coverage for the entire protected area!

When using the Remote Control device, it is recommended to perform the LuNAR Self Test; for further instructions refer to the Remote Control Instructions.

Upon completion of installation and testing stages, ensure that all switches are in their desired positions.

**IMPORTANT:**

Turn DIP switch 7 "OFF" after installation and when leaving the site for security reasons. This will prevent unauthorized use of a remote control unit, that may be used to disable the detector.

Troubleshooting

This section describes possible system problems and their solutions:

Always perform the following preliminary checks before referring to the troubleshooting table:

Perform a complete visual inspection of the LuNAR, for signs of mechanical damage, loose connections or torn wires.

Check the connections of the incoming AC power source.

Trouble	Meaning	Response
ProSYS Configuration of detectors fails/not accepted by the system	ID configuration problem	Disconnect all power sources, configure the desired IDs and reconnect power again
Tamper indication while working in the BUS mode	Tamper connection malfunction	Verify that both DIP 8 and 9 are in ON position
Tamper indication in the Relay or BUS mode	Tamper probably not closed	Visually verify that ceiling tamper and spring are correctly installed
Walk test cannot be initiated via the ProSYS keypad	Wrong code	Insert the appropriate code
Green LED doesn't operate during Walk test - MW channel does not function	Industrial LuNAR is configured (via the ProSYS) to the "MW disable on DISARM" during ProSYS's DISARM mode	Normal behavior
	Industrial LuNAR operating in Bypass mode due to "Bypass MW channel mode"	Reset the detector. If MW channel trouble reoccurs, replace the detector with a new one

Specifications

Coverage	Coverage pattern consists of 192 fingers (96 Fresnel facets) divided into 3 lens sections. Each lens section has 4 adjustable vertical positions for variable mounting height and customized coverage. 360° by 18m (59ft) diameter. When mounting the detector under 3.7m, the coverage diameter starts to decrease up to 15m (50ft).
Variable Mounting Height	From 2.7m to 8.6m (9' to 28'), 4 lens positions according to installation height
RFI immunity	40 V/m from 10MHz to 1GHz
Operating voltage	9 to 16VDC
Current consumption	20mA at 12VDC, 30mA at 16 VDC, Maximum 40mA with all LEDs on.
Alarm and AM contacts	Opto-relay NC, 100mA, 24 VDC
Tamper contacts	NC, 500mA, 24 VDC
Alarm Time	2.2 seconds
Warm-up time	2 minutes
Optical Filtering for white light protection	Pigmented Fresnel lens
Operating temperature	-20° C to 55° C (-4° F to 131° F)
Storage temperature	-20° C to 60° C (-4° F to 140° F)
Dimensions (Height x Diameter)	99mm x 194mm (3.9"x 7.6")

The **Industrial LuNAR DT AM Grade 3** detector is suitable for use in installations complying with PD6662, EN50131-1 and TS50131-2-4 Grade 3, Class II.

Ordering Information

Part Number	Description
RK200DTG300A	Industrial LuNAR DT AM Grade 3 Detector, 10.525GHz
RK200DTG3UKA	Industrial LuNAR DT AM Grade 3 Detector, 10.687GHz
RK200DTG3FRA	Industrial LuNAR DT AM Grade 3 Detector, 9.9GHz
RK200DTG3DEA	Industrial LuNAR DT AM Grade 3 Detector, 9.35GHz
RK200RC0000A	Industrial LuNAR Remote Control



Table for P/N: RK200DTG300A

AT	BE	CZ	DE
DK	ES	FI	FR
GR	IE	IT	it
LU	MT	NL	PT
SE	UK		

Table for P/N: RK200DTG3FRA

AT	BE	CZ	DE
DK	ES	FI	FR
GR	IE	IT	it
LU	MT	NL	PT
SE	UK		

The P/N: RK200DTG3UKA intended for use in the UK only!

The P/N: RK200DTG3DEA intended for use in Germany only!

FCC NOTE:

Refers to P/N: RK200DTG3xxA

This equipment has been tested and found to comply with the limits for a Class B digital device, pursuant to part 15 of the FCC Rules. These limits are designed to provide reasonable protection against harmful interference in a residential installation. This equipment generates, uses and can radiate radio frequency energy and, if not installed and used in accordance with the instructions, may cause harmful interference to radio communications. However, there is no guarantee that interference will not occur in a particular installation. If this equipment does cause harmful interference to radio or television reception, which can be determined by turning the equipment on and off, the user is encouraged to try to correct the interference by one or more of the following measures:

- Reorient or relocate the receiving antenna.
- Increase the separation between the equipment and the receiver.
- Connect the equipment into an outlet on to a different circuit from that to which the receiver is connected.
- Consult the dealer or an experienced radio/TV technician for help.
- Changes or modifications to this equipment which are not expressly approved by the party responsible for compliance RISCO Group could void the user's authority to operate the equipment.

RISCO Group Limited Warranty

RISCO Group and its subsidiaries and affiliates ("Seller") warrants its products to be free from defects in materials and workmanship under normal use for 24 months from the date of production. Because Seller does not install or connect the product and because the product may be used in conjunction with products not manufactured by the Seller, Seller can not guarantee the performance of the security system which uses this product. Sellers obligation and liability under this warranty is expressly limited to repairing and replacing, at Sellers option, within a reasonable time after the date of delivery, any product not meeting the specifications. Seller makes no other warranty, expressed or implied, and makes no warranty of merchantability or of fitness for any particular purpose.

In no case shall seller be liable for any consequential or incidental damages for breach of this or any other warranty, expressed or implied, or upon any other basis of liability whatsoever.

Sellers obligation under this warranty shall not include any transportation charges or costs of installation or any liability for direct, indirect, or consequential damages or delay.

Seller does not represent that its product may not be compromised or circumvented; that the product will prevent any person; injury or property loss by intruder, robbery, fire or otherwise; or that the product will in all cases provide adequate warning or protection. Buyer understands that a properly installed and maintained alarm may only reduce the risk of intruder, robbery or fire without warning, but is not insurance or a guaranty that such will not occur or that there will be no personal injury or property loss as a result.

Consequently seller shall have no liability for any personal injury, property damage or loss based on a claim that the product fails to give warning. However, if seller is held liable, whether directly or indirectly, for any loss or damage arising from under this limited warranty or otherwise, regardless of cause or origin, sellers maximum liability shall not exceed the purchase price of the product, which shall be complete and exclusive remedy against seller.

No employee or representative of Seller is authorized to change this warranty in any way or grant any other warranty.

WARNING: This product should be tested at least once a week

Contacting RISCO Group

RISCO Group is committed to customer service and product support. You can contact us through our website (www.riscogroup.com) or at the following telephone and fax numbers:

United Kingdom

Tel:+44-161-655-5500

sales@riscogroup.co.uk

technical@riscogroup.co.uk

Italy

Tel: +39-02-66590054

info@riscogroup.it

support@riscogroup.it

Spain

Tel:+34-91-490-2133

sales-es@riscogroup.com

support-es@riscogroup.com

France

Tel: +33-164-73-28-50

sales-fr@riscogroup.com

support-fr@riscogroup.com

Belgium

Tel: +32-2522 7622

sales-be@riscogroup.com

support-be@riscogroup.com

USA

Tel:+305-592-3820

sales-usa@riscogroup.com

support-usa@riscogroup.com

Brazil

Tel:+55-11-3661-8767

sales-br@riscogroup.com

support-br@riscogroup.com

China

Tel: +86 - 21-52-39-0066

sales-cn@riscogroup.com

support-cn@riscogroup.com

Israel

Tel: +972-3963-7777

info@riscogroup.com

support@riscogroup.com

All rights reserved.

No part of this document may be reproduced in any form without prior written permission from the publisher.



©RISCO Group 12/07

5IN200DTG3